

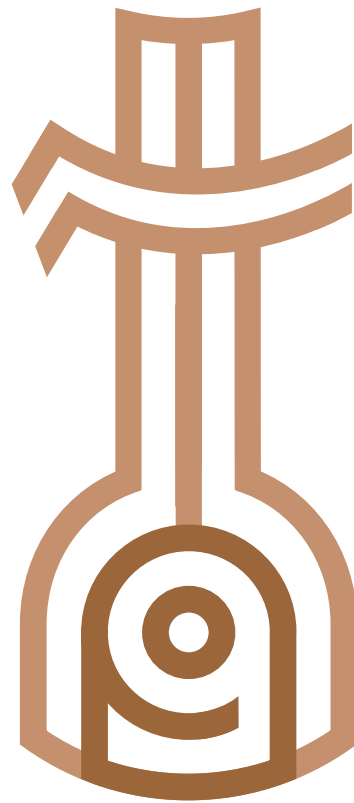

Making pottery

YEAR/2022

Logo Designer/Reyhaneh Halaj



AUA

• لوگو ساخت ظروف سفالی آوا:  
این دستان توانمند یک سفالگر  
است که آنچه در ذهن او نقش  
میپندد خلق میکند.  
در طراحی لوگو دستانی را  
می بینیم که حرف (و) را ساخته  
و ترکیب بندی کلی به شکل ظرف  
سفالی می باشد .

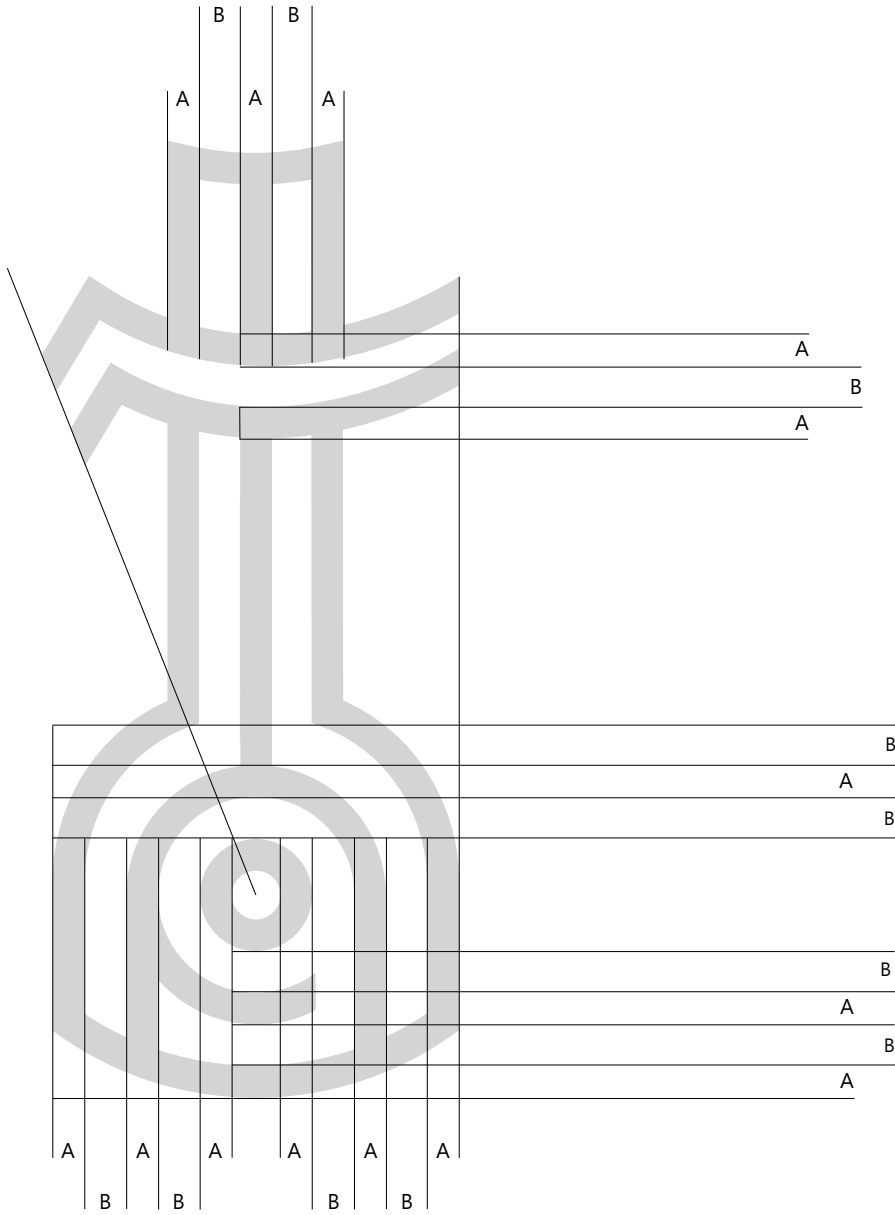

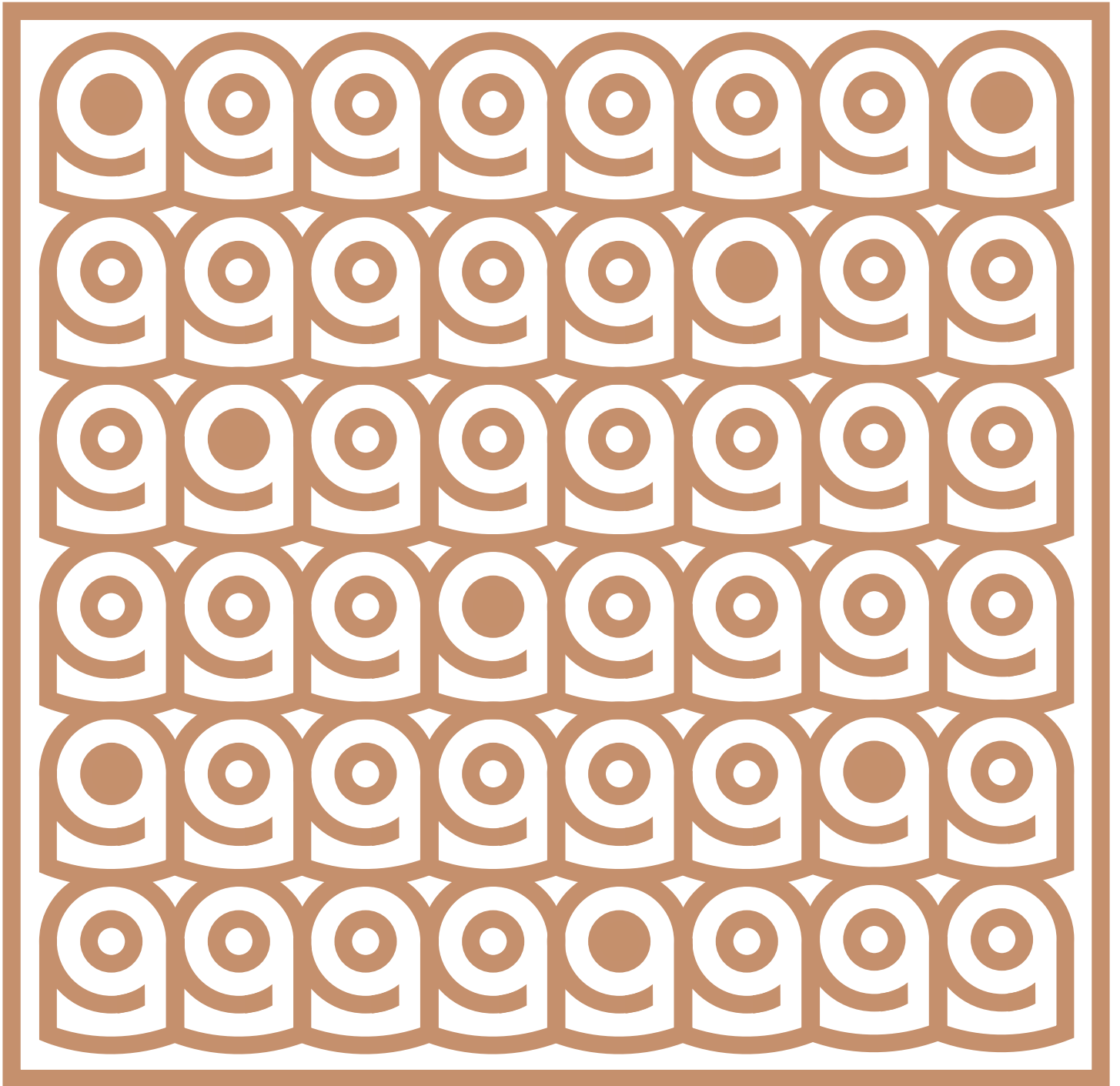

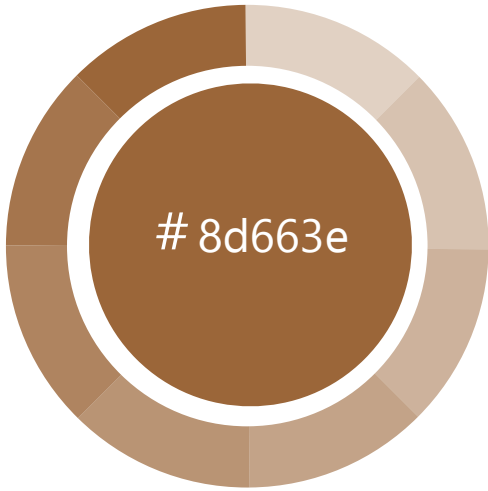

CMYK  
C:32 M:59 Y:85 K:18

RGB  
R:141 G:102 B:62

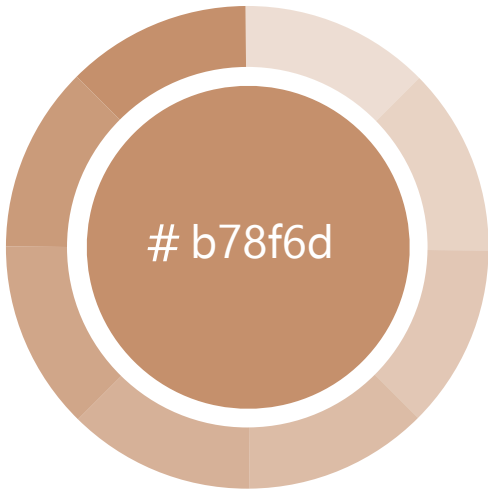

CMYK  
C:22 M:45 Y:61 K:2

RGB  
R:183 G:143 B:109





STUDIO • HALAJ

Beauty salon  
YEAR/2022  
Logo Designer/Reyhaneh Halaj



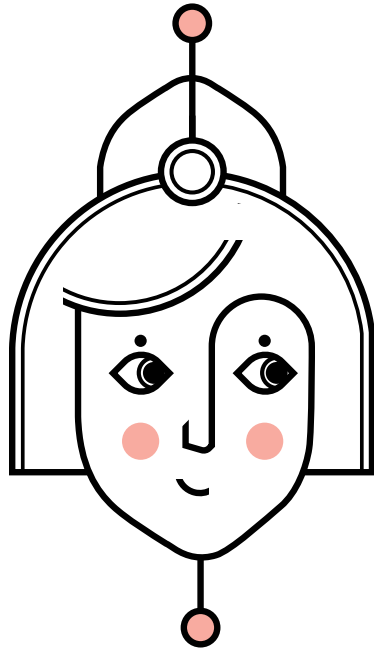

میریانا  
Beauty salon

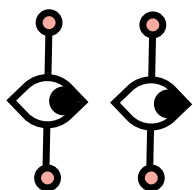

لوگو سالن زیبایی فریفا:

الویت در طراحی نشانه فریفا نشان دادن چهره ی ظریف و زیبا و تلفیق آن با حرف (ف) می باشد به همین جهت بالای چشم ها نقطه قرار داده شده و از فرم تاج برای القا شکوه و بزرگی استفاده شده است.

همان گونه که مشخص است از فضای داخل لوگو تصویری برای تایپ استفاده شده تا هماهنگی کامل یا یک دیگر داشته باشد.

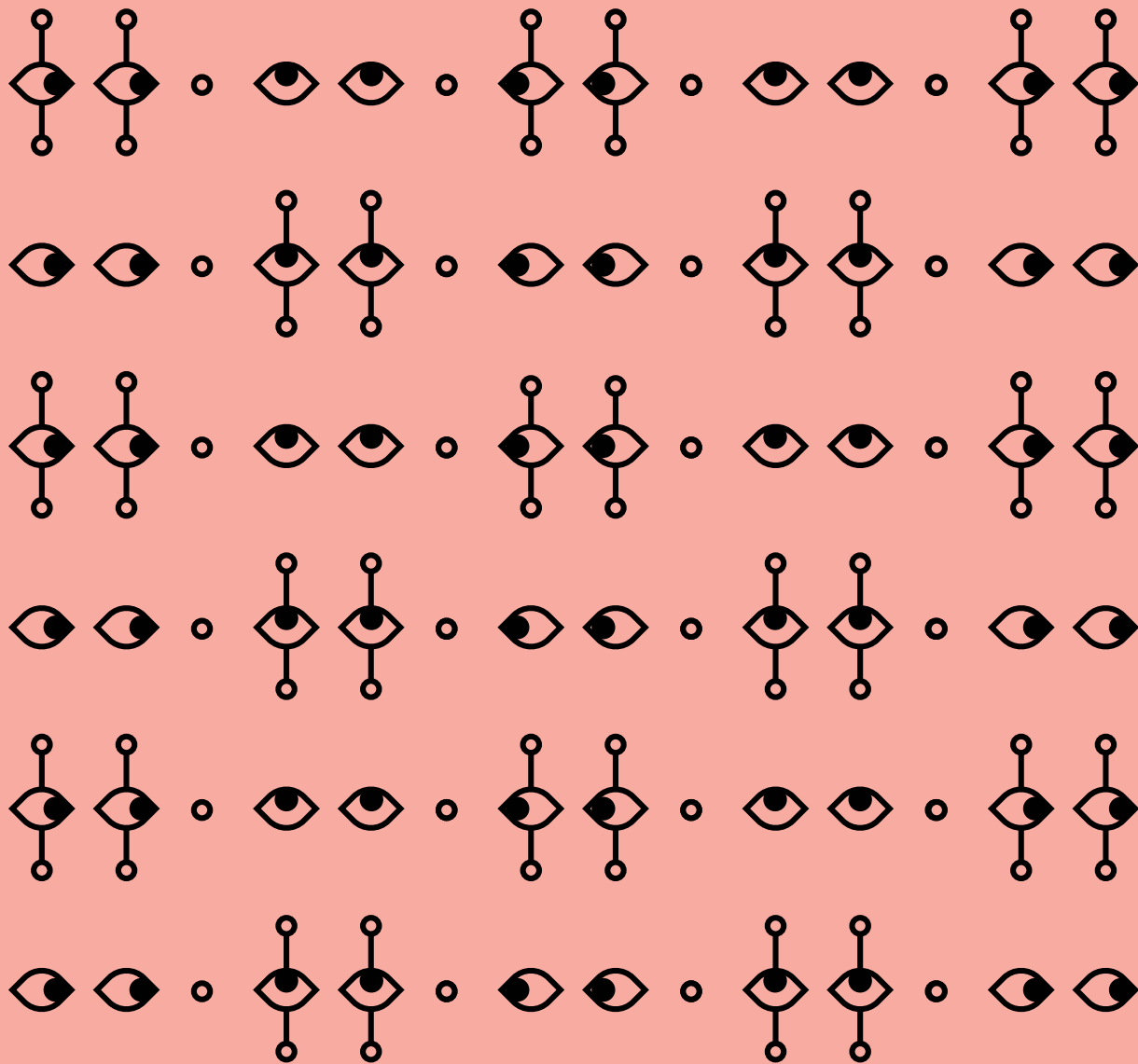

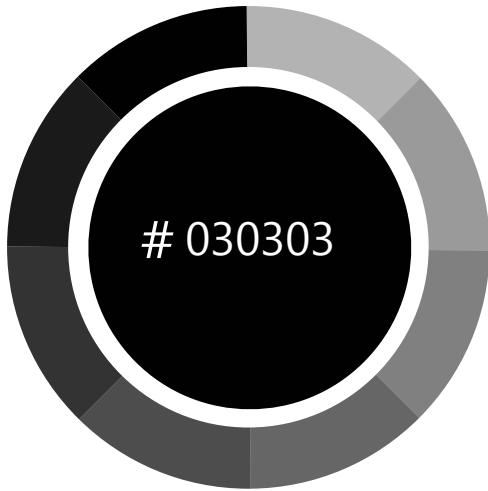

CMYK  
C:75 M:68 Y:67 K:90

RGB  
R:3 G:3 B:3

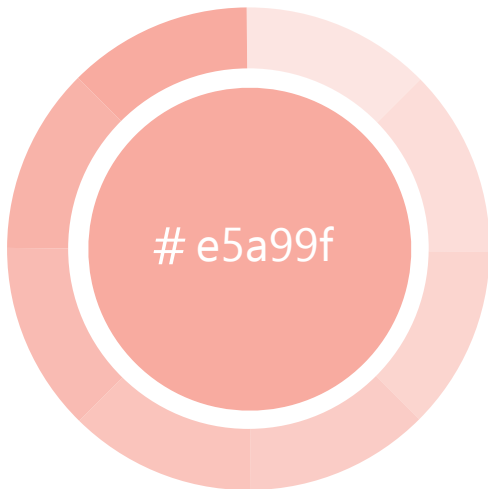

CMYK  
C:00 M:40 Y:29 K:00

RGB  
R:229 G:169 B:159

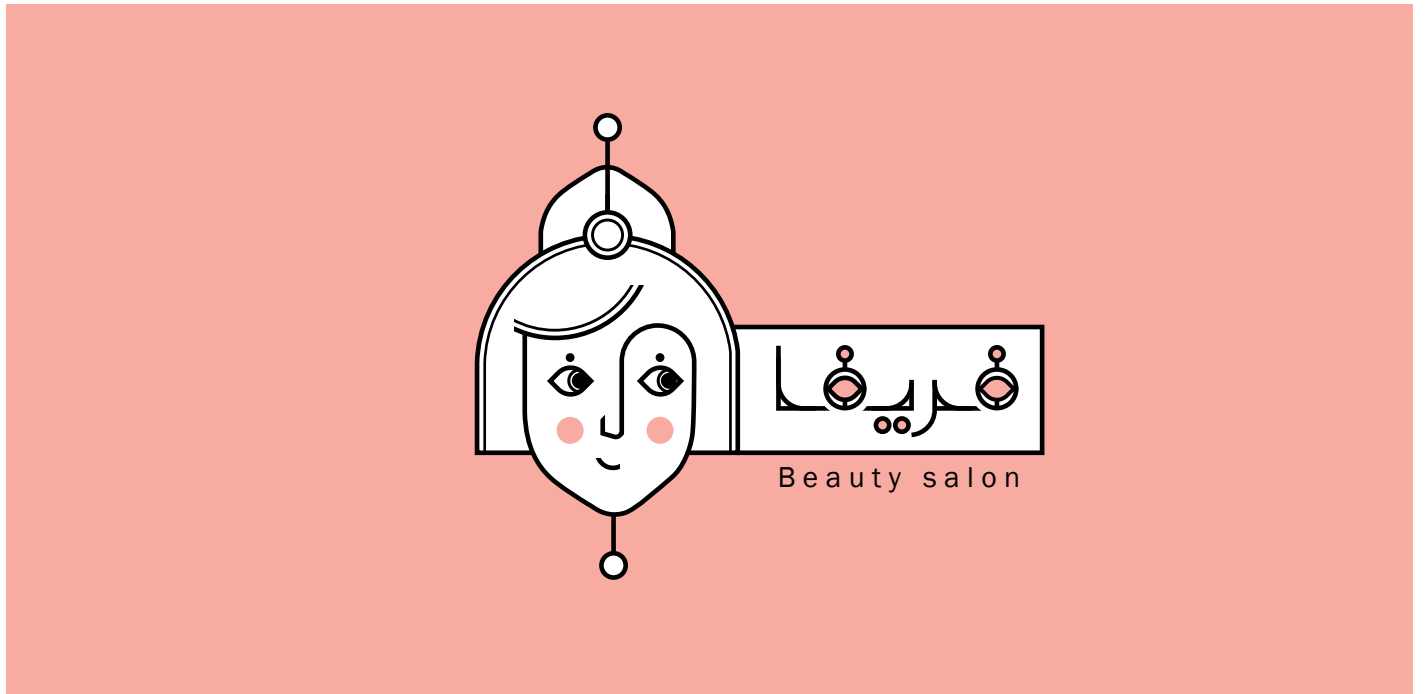
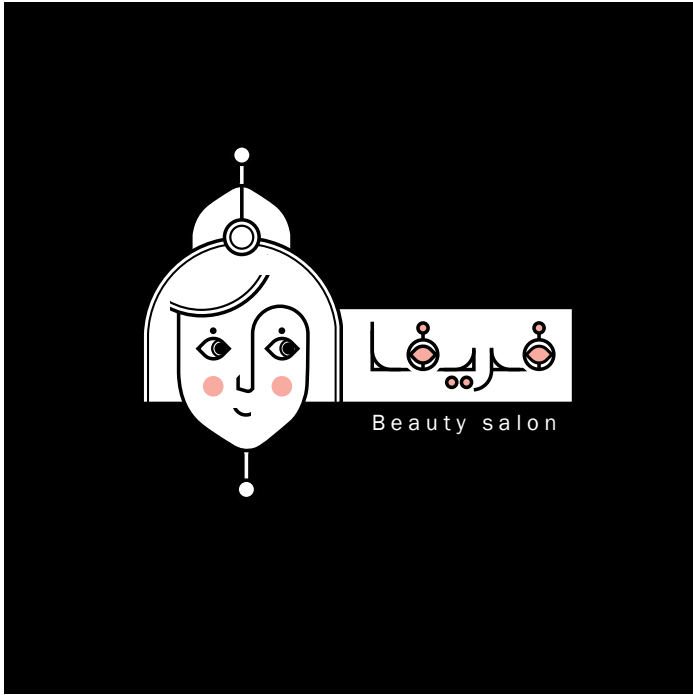



Don Donut  
YEAR/2022  
Logo Designer/Reyhaneh Halaj



DON —  
DONUT

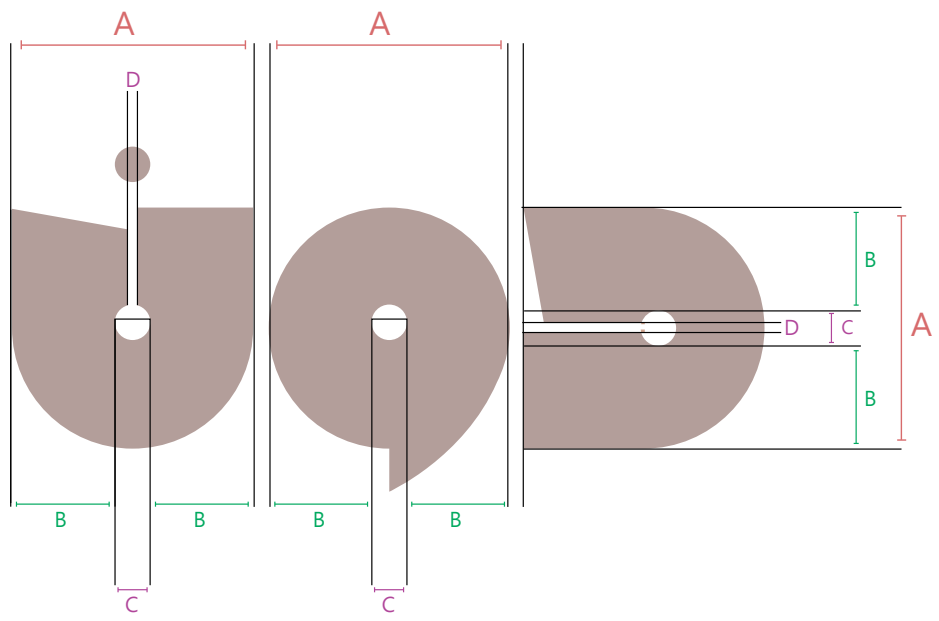



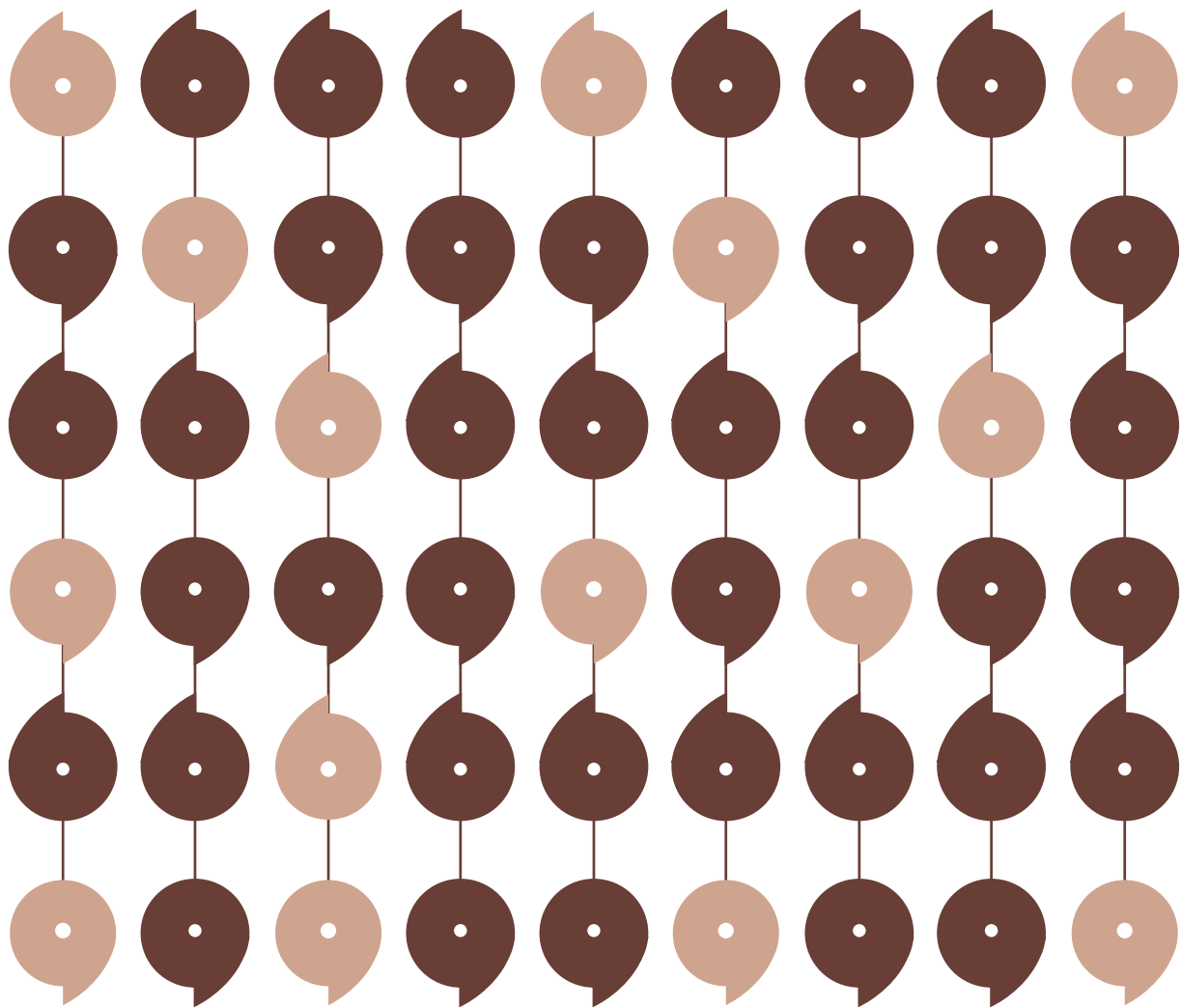

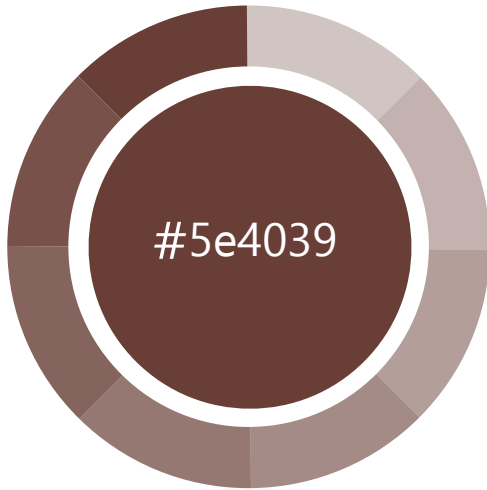

CMYK  
C:42 M:71 Y:70 K:43

RGB  
R:94 G:64 B:57

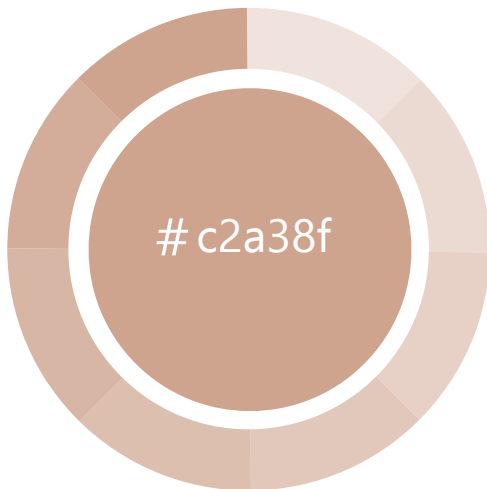

CMYK  
C:19 M:37 Y:42 K:00

RGB  
R:194 G:163 B:143

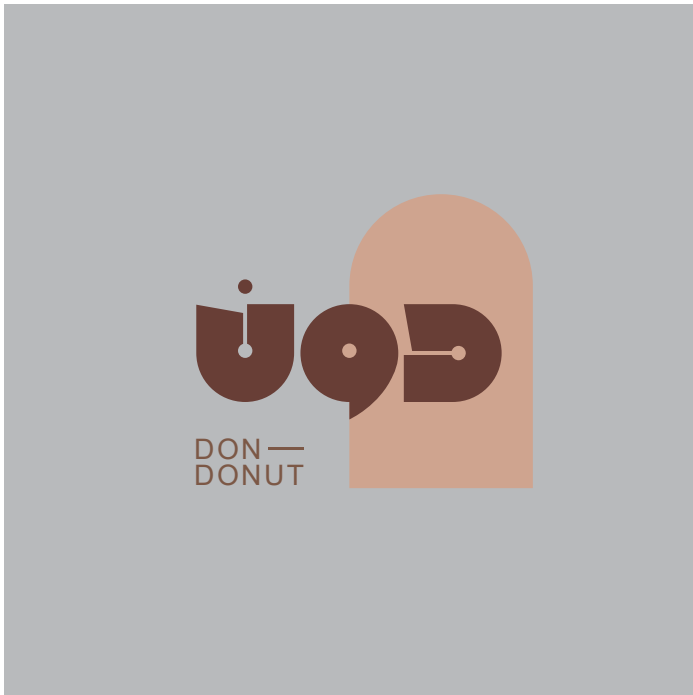
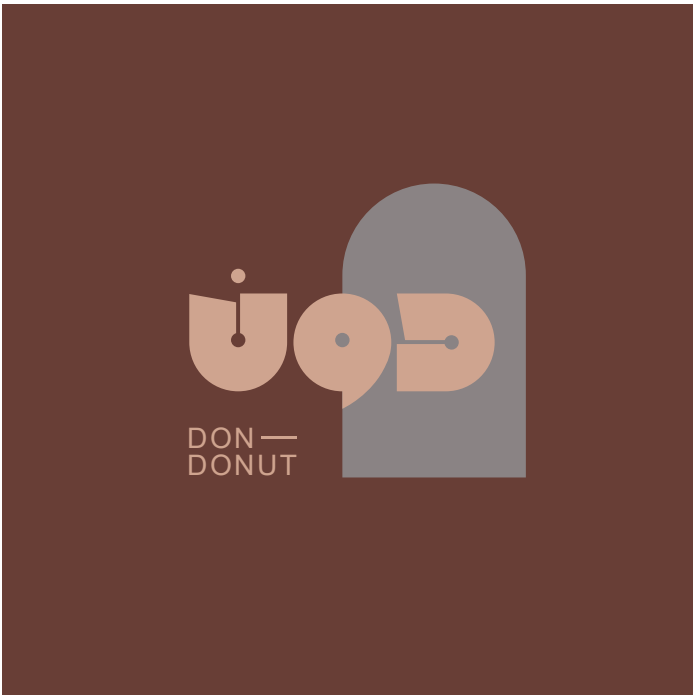



Handmade Soap

YEAR/2022

Logo Designer/Reyhaneh Halaj



TORANJ  
صابون دستساز



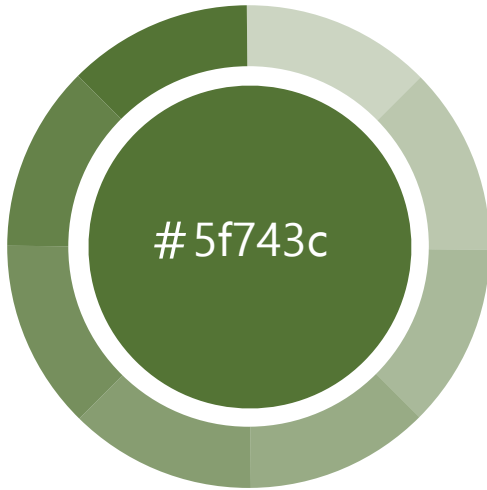

CMYK  
C:69 M:34 Y:99 K:21

RGB  
R:95 G:116 B:60

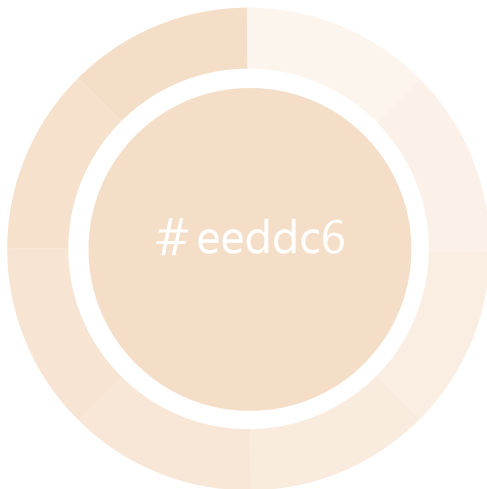

CMYK  
C:2 M:13 Y:21 K:00

RGB  
R:238 G:221 B:198

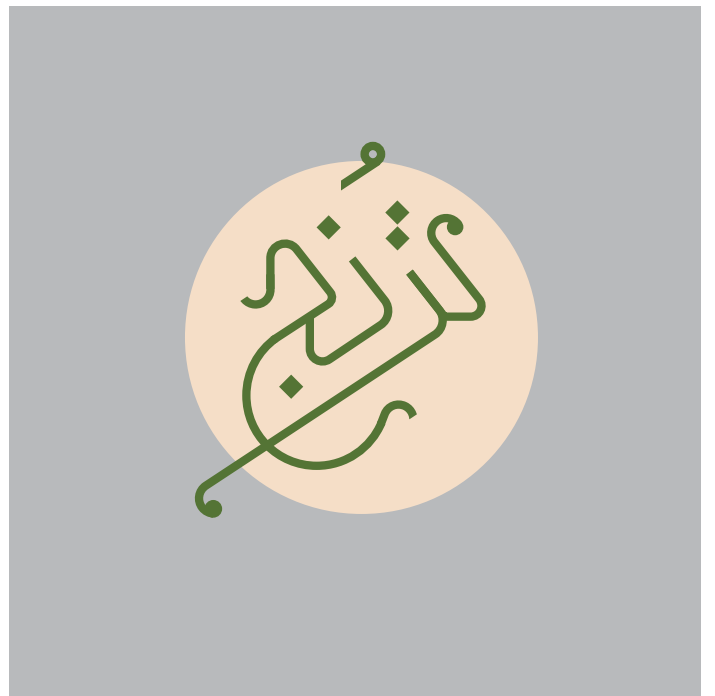
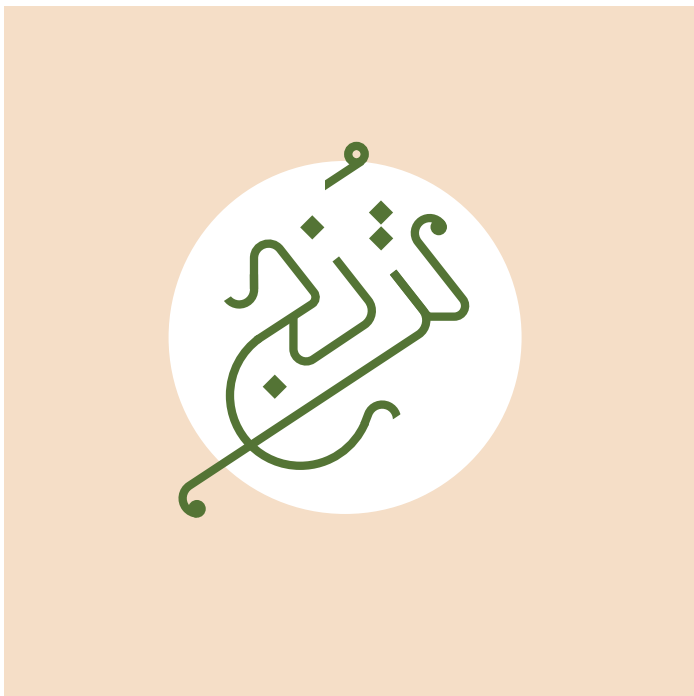
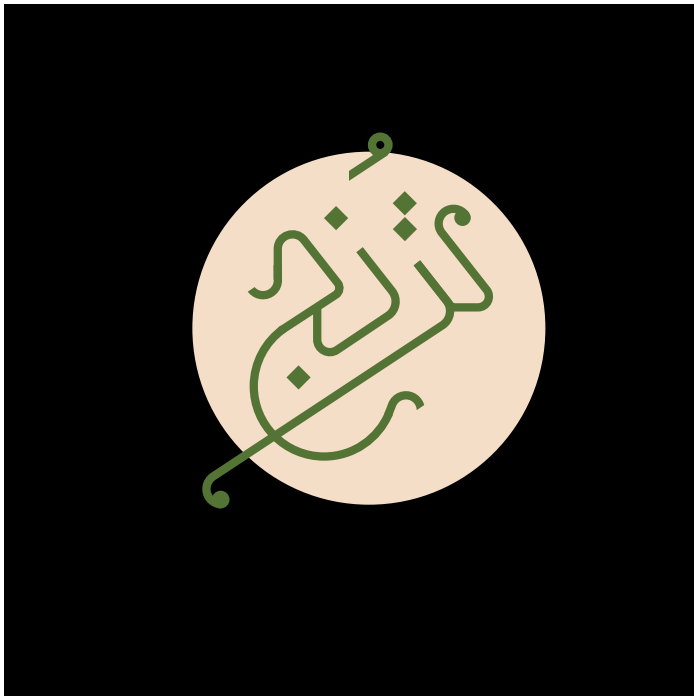

# بنوش

BENOSH  
Herbal tea



Herbal Tea  
YEAR/2022  
Logo Designer/Reyhaneh Halaj





BENOSH  
Herbal tea

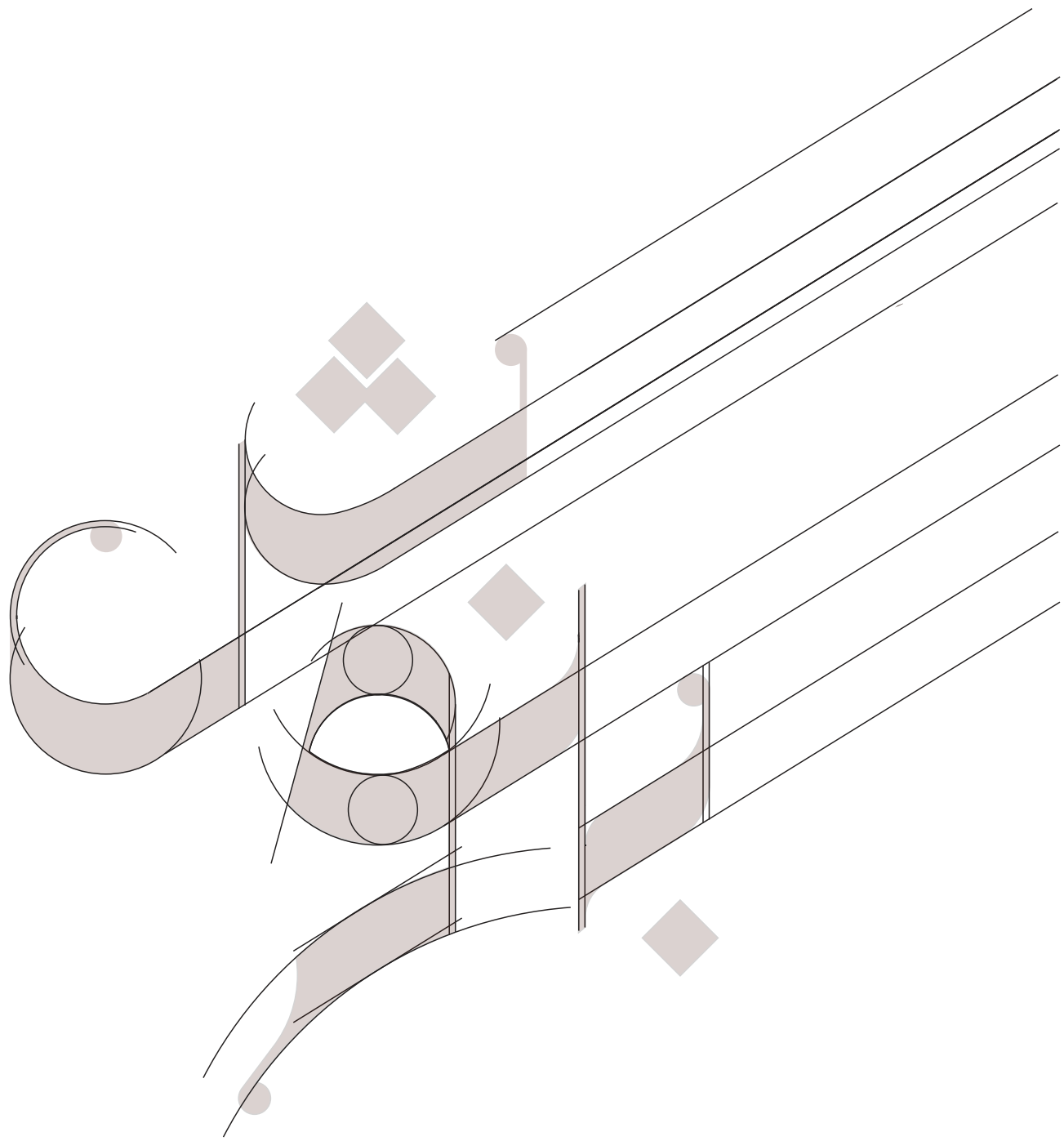



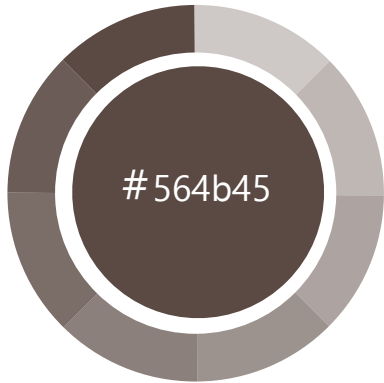

#564b45

CMYK

C:55 M:61 Y:64 K:40

RGB

R:86 G:75 B:69

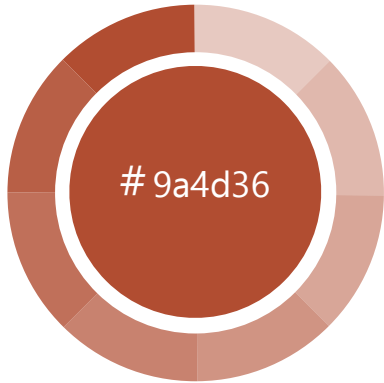

#9a4d36

CMYK

C:22 M:81 Y:90 K:13

RGB

R:154 G:77 B:54

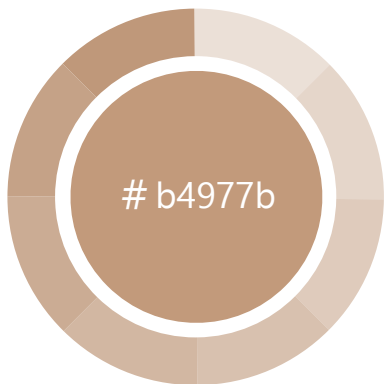

#b4977b

CMYK

C:25 M:40 Y:54 K:00

RGB

R:180 G:151 B:123



Gole Sorkh Restaurant visual identity

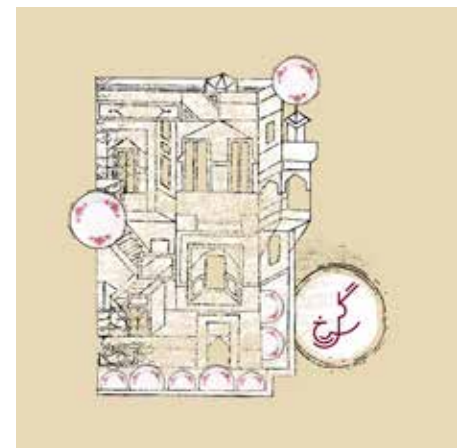
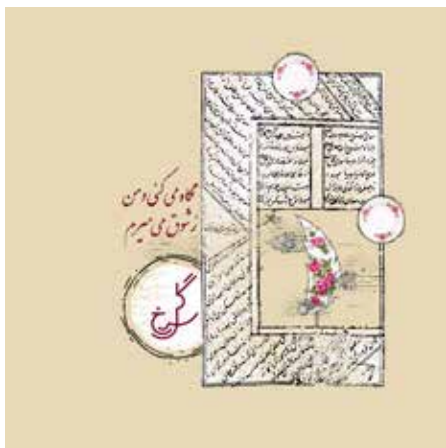
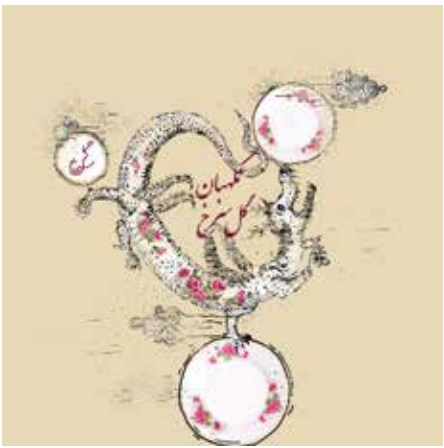
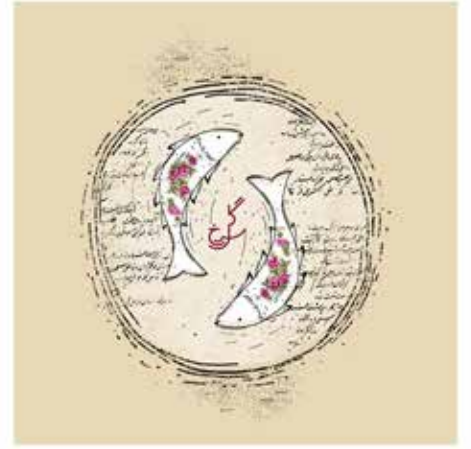
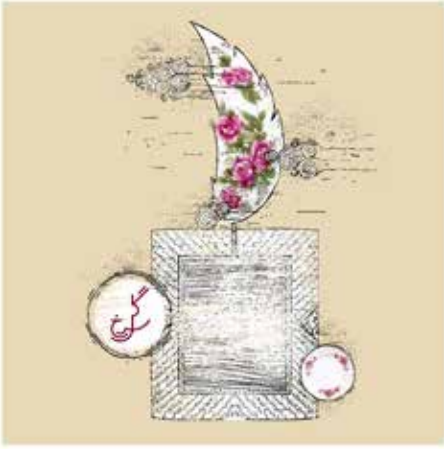

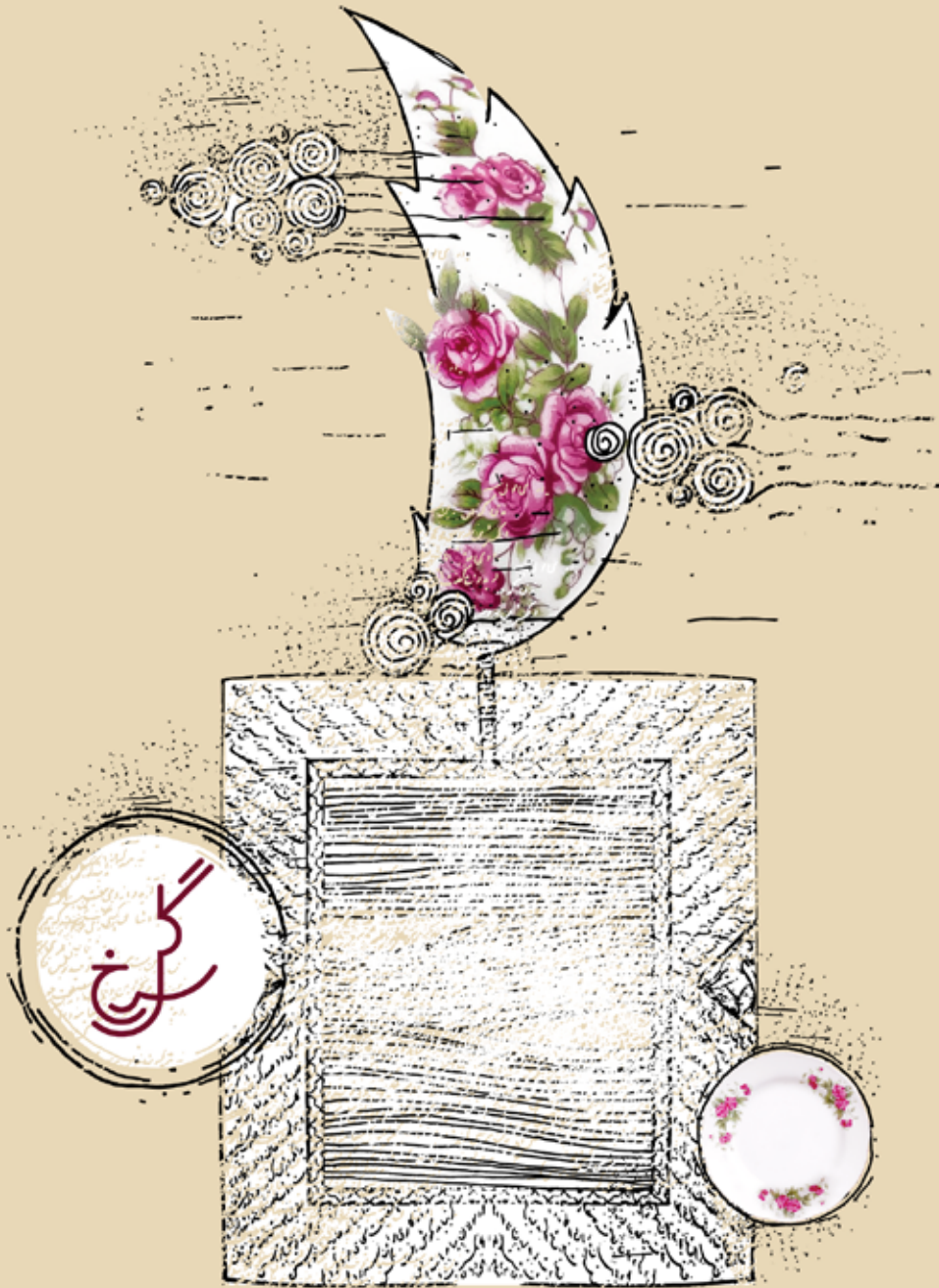







## Bros Restaurant visual identity

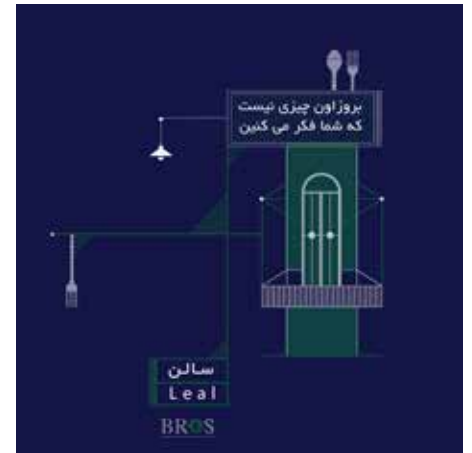



بروز اون چیزی نیست  
که شما فکر می کنین

بام: سالن Leprechaun



BROS

بروزاون چیزی نیست  
که شما فکر می کنین

سالن Leo



BROS



Bros Restaurant  
YEAR/2021  
Designer/Reyhaneh Halaj



Bros Restaurant  
YEAR/2021  
Designer /Reyhaneh Halaj

■ Namakdan Restaurant visual identity



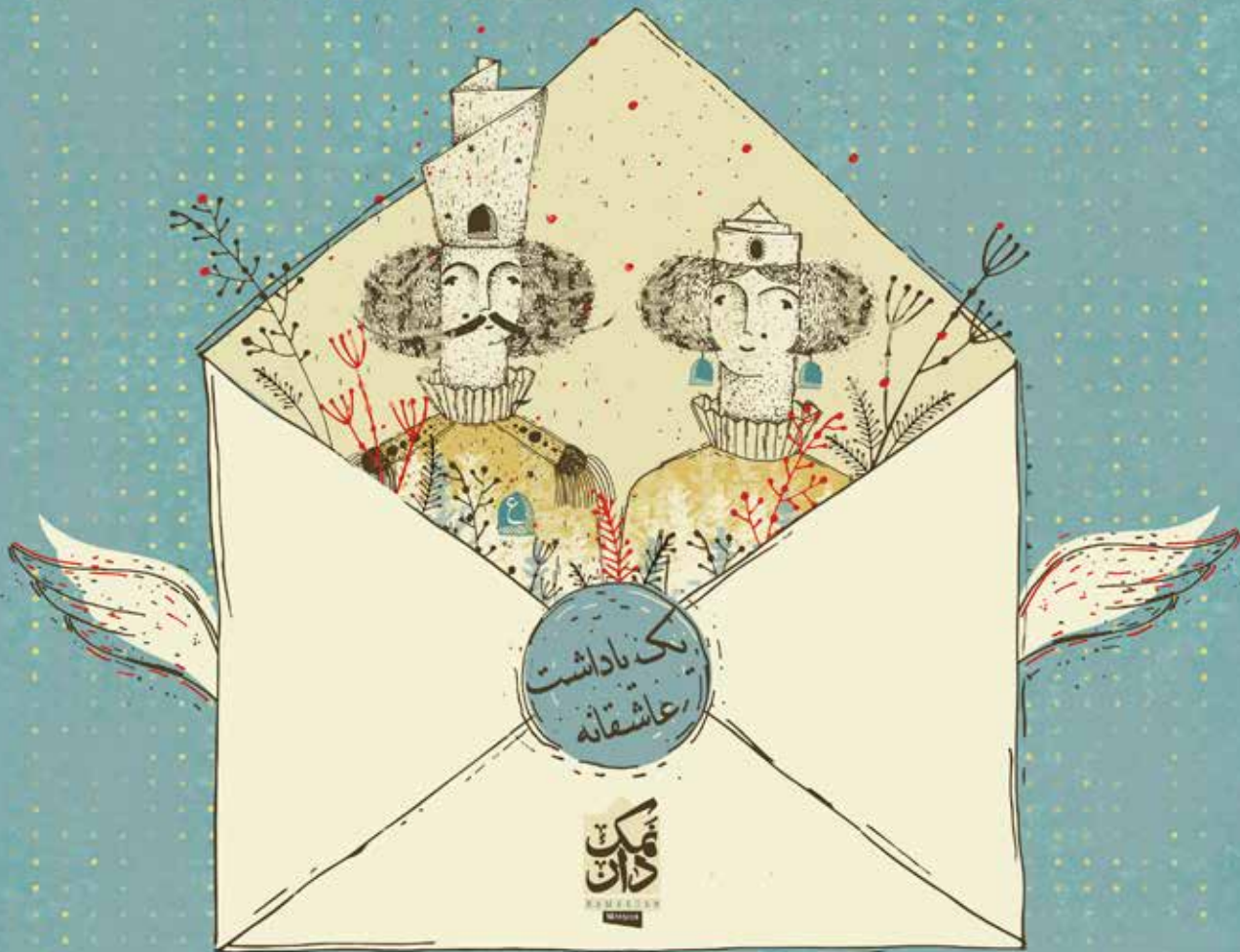





فكر  
دان  
Manson

مسابقه

غذا با (الف)...؟

ریحانه حلاج  
متولد ۱۳۷۴  
کارشناسی گرافیک  
۶ سال سابقه فعالیت

